



SCHIEBEN

PRODUCT CATALOG

Enhance Your Accuracy

www.schiebenstores.com



TABLE OF CONTENTS

👉 Pumps	-----	02
👉 Compressor	-----	04
👉 Pumps & Compressor Spares	-----	05
👉 Cases & Covers	-----	08
👉 Plinking & Chronograph	-----	12
👉 Bipods & Tripods	-----	14
👉 CO ₂ Capsules & BB Balls	-----	18
👉 Carbon Fiber Cylinders & Buddy Bottle	-----	19
👉 Accessories	-----	22
👉 Spares & Maintenance	-----	25
👉 Mounts & Optics	-----	27
👉 Lasers and Torches	-----	33
👉 Cleaning Kit & Maintenance	-----	36

Our locally sourced and directly imported products are quality-tested to ensure top performance at the best prices—no middlemen involved.

Welcome to Our World of Scheiben Store

Schieben is a fourth-generation Arms & Ammunition brand, shifting from wholesale to e-commerce to offer quality products directly at fair prices.

About US

Schieben is the vision of a fourth generation Arms & Ammunition Dealer we were into wholesale business supporting various Air Guns and Arms dealer with quality product, while doing some research on internet when we found a huge disparity between our wholesale prices and the prices which was being offered to the end client we decided to foray in E commerce retail of the business.

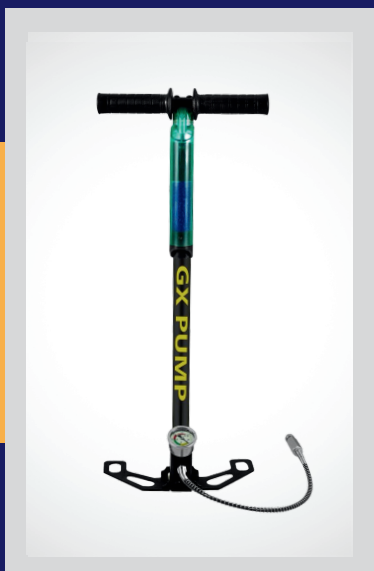

Gx Dry Pack Pump

High-Pressure, High-Efficiency Design:

The GX pump's exclusive 3.5-stage system delivers more air per stroke, requiring less effort and fewer strokes to fill tanks. It includes a 90% effective oil-moisture filter, keeping air dry for safe scuba or air gun use.

- Length : 625mm (closed) – 1050mm (Opened)
- Weight: 3.1 kgs
- Max : Fill pressure: 300bar/ 4350psi
- Pedal: Classical Foldable Pedal
- Color: Camoufalge, Black, Silver
- Output Nut : M10*1, quick Connector : 8mm
- Weight 3 kg
- Dimension 64 X 20X 15 cm

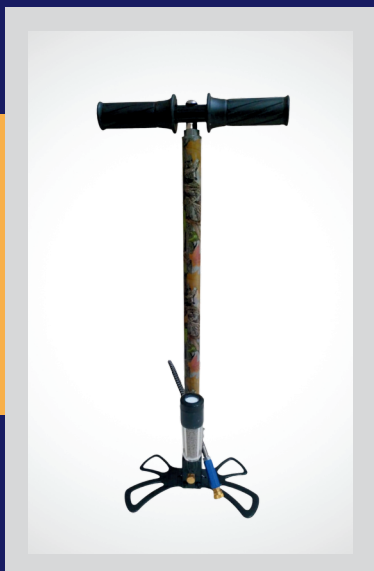

Hill Type Dry Pack

- The Hill type hand pump with Dry-Pack sets a new standard in high-pressure hand pumps.
- With an improved manometer, you can easily monitor your progress as you pump up to 300 bar (4500 psi), now with 20% less effort.
- Maintenance is simpler than ever, thanks to a streamlined internal design.
- The Dry-Pack system filters out 90% of moisture, ensuring your PCP air gun is filled with clean, dry air.
- A convenient bleed valve allows for fast and easy release of excess pressure.
- This model includes a hose fitted with a 1/8 BSP female foster connection.
- Weight 3 kg
- Dimension 64 X 20X 15 cm

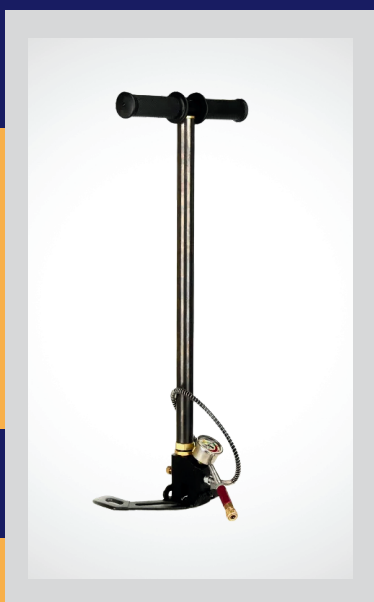

3 Stage Plus PCP Pump

This model adds a more effective filter based on the original three-stage folding, which is equivalent to double-layer filtration.

- Pumps to 4,500 psi/310 bar (always use the correct pressure rating for your gun)
- High Pressure Hose length 500 mm.
- Material : Stainless steel
- Quick-disconnect female fitting on hose & pump base.
- With extra repair kits inside
- Patented design, easy to disassemble and repair
- Folding feet.
- Extra in – line filter included.
- Weight 3 kg
- Dimension 64 X 20X 15 cm

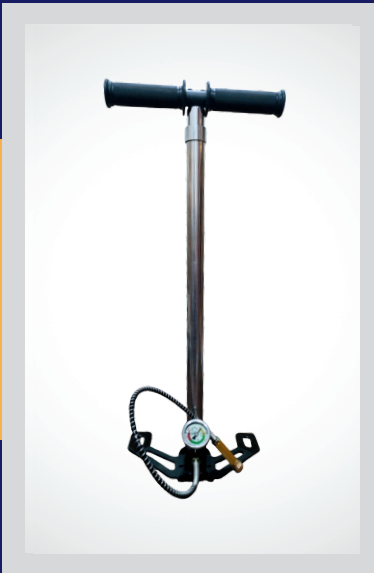

4 Stage PCP Pump

- The 4-stage PCP hand pump is a manual air pump used to fill Pre-charged pneumatic airguns.
- Pumps to 4,500 psi/310 bar (always use the correct pressure rating for your gun)
- High Pressure Hose length 500 mm .
- Material : Stainless steel
- Quick-disconnect female fitting on hose.
- With extra repair kits inside
- Patented design, easy to disassemble and repair
- Folding feet .
- Weight 3 kg
- Dimension 64 X 20X 15 cm

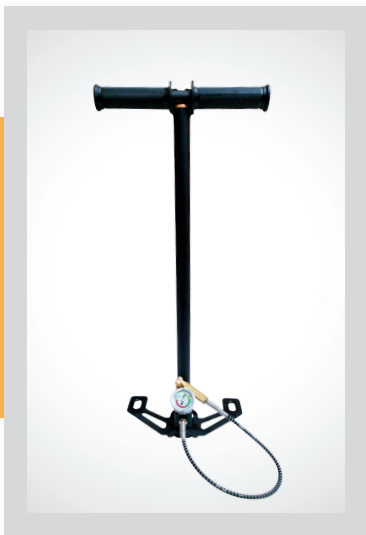

3 Stage PCP Pump (Black)

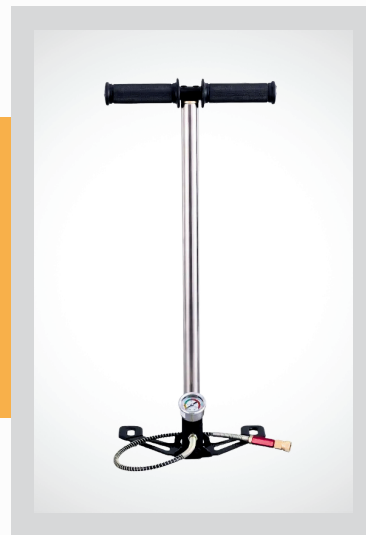

3 Stage PCP Pump (Silver)

3 stage high pressure hand pump, pressure goes up to 4500psi, with smooth upward and downwards motion, 30% more efficient than traditional pumps; PCP hand pump is designed with pressure gauge for monitor pressure level precisely.

- PCP high -pressure pump use for air driving
- cylinders and PCP cylinder, safe and
- convenient
- Max pressure is 4500psi with high grade 304
- stainless steel pump body.
- It comes with O rings and other complete accessories and it is suitable for most brand of PCP pistols, rifles and airguns.
- Weight 3 kg
- Dimension 64 X 20X 15 cm
- Color : Black/ Silver



High Pressure Air Compressor

- Adjustable auto-Stop PCP electric air pump power: 110V 60HZ; Motor power : 1.8 K W. Air pump inflating speed : 2800 r/min; Work flow : 50 L/min; Oil standard : ISO VG 46 & AW 46.
- Designed with two-stage compression and two water-oil separators for performance stability. It takes only 30 minutes to fill full 6.8L tank to 300BAR.
- PCP electric pump can be used for fire fighting, paintball, leakage detecting, pressure-tight test, automobiles, air impermeability test, pressure proof test, etc

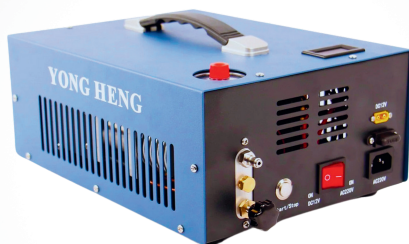

YH-QB12

- Auto-Stop at adjustable pressure from 0-300 Bar
- 12L/Min | 12V, 110V, 220V 0.5 Litre Tank from 0 bar to 300 bar
37.5*20.2*22.5cm, 9.0 kgs per unit



YH-QB01-PS

- Auto-Stop at adjustable pressure from 0-300 Bar 50L/Min | 1.8 KW | 220V/ 110V

PUMPS & COMPRESSOR SPARES

Repair Kit For 3 Stage PCP Pump



Repair Kit For 4 Stage PCP Pump



These Repair Kits for a 3 and 4 Stage PCP Hand Pump is a comprehensive set designed to keep your pump in optimal working condition. Perfect for maintaining the performance and longevity of your hand pump, this kit includes all essential components such as seals, O-rings, and other vital parts that are prone to wear and tear. Easy to use and durable, this repair kit ensures your pump operates smoothly and efficiently, minimizing downtime and enhancing your shooting or diving experience.

Compressor Repair Kit Water Cooler

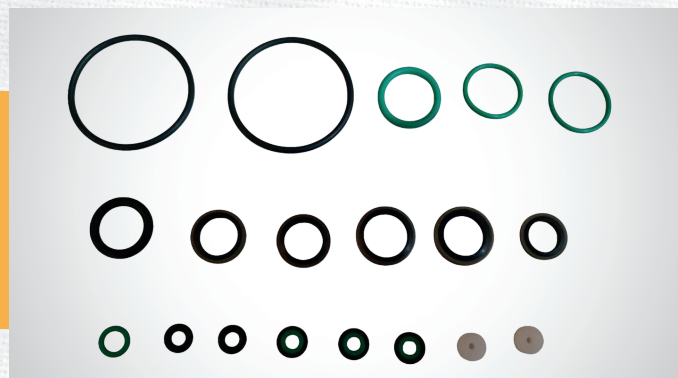

Compressor Repair Kit DC 12V

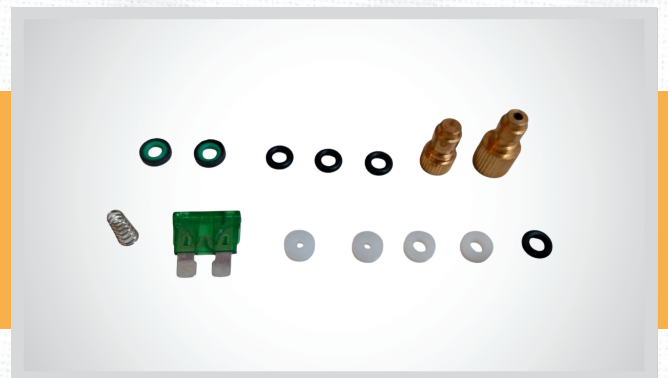

This is a special maintenance kit for PCP air compressors. The kit contains all wearing parts that may need to be replaced during daily maintenance. We also stock all major spares for compressor



Silicon Oil

30ml Silicone Oil for PCP Pump Maintenance and Tools Parts

PUMPS & COMPRESSOR SPARES

Small Filter

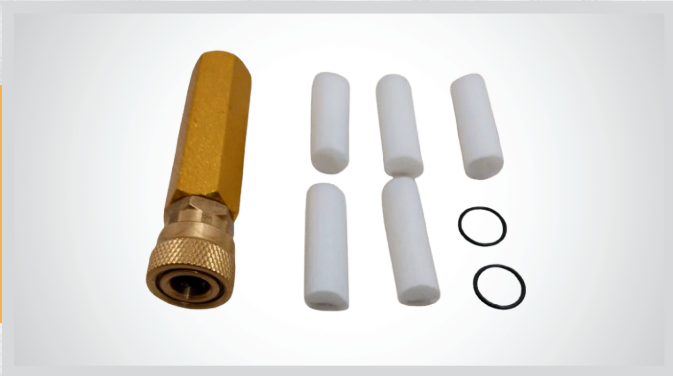

Use this Air Filter on your air hand pump or air compressor hose to filter the oil, moisture and impurities when you fill your pcp bottle.

- Material: Aluminum
- Length: 65 cm
- Thread: M10x1 female

Big Filter



A perfect and practical replacement parts for Hand Operated Air pump, PCP, Air Compressor, etc.

- Material : Aluminum
- Length: 95 cm
- Thread: M10x1 female

Compressor Filter



- Oil-water separator thread is double M10 x 1 female; Additional 2 Connectors with M10 x 1 Male plug and M10 x 1 Male quick connector
- 2-stage filtration design: first-stage absorbent cotton, second-stage desiccant filter; Enlarged diameter and length design, more filling capacity, further improved filtering effect
- A perfect and practical replacement parts for hand Operated Air pump, PCP, Air Compressor, etc.

Package content:

- 1 x Oil-water Separator
- Filters element: 6 PCS
- Seal Ring: 2 PCS

PUMPS & COMPRESSOR SPARES

Compressor Oil



Compressor Oil is a high-performance lubricant designed specifically for air compressors, featuring a high viscosity index and excellent thermal stability, ensuring optimal operation and longevity across various compressor models.

HP Hose



- High Pressure Hose 63mpa Air Pump Accessories 52 cm is designed to provide exceptional results with advanced technology.
- Built with precision engineering to ensure long-lasting durability.
- Features an innovative design for improved usability and efficiency.
- Ideal for Durable applications, making it versatile and practical.
- Compact yet powerful, offering convenience without compromising performance.

CASES & COVERS



Sig Pistol Case

Sig style pistol case is constructed of a durable polymer that is lined with foam inserts for added protection.

Size: L x B x H
34 cm x 24 cm x 8 cm



Glock Pistol Case

The Glock style pistol case has room for one pistol & is made of durable black polymer & egg-crate foam lines the interior.

Size: L x B x H
27 cm x 23 cm x 6 cm



Tactical Pistol Case

Tactical style pistol case is crafted from impact-resistant materials, providing robust protection for your handgun & accessories during storage & transport.

Size: L x B x H
30 cm x 25 cm x 8 cm



Hard Rifle Case

A hard rifle case that gives great protection to your equipment with enough storage for all your accessories.

55" Inch/ 47 Inch
Size: L x B x H
120 cm x 30 cm x 8 cm
140 cm x 30 cm x 8 cm



Holster Fibre Glock 17

- Model Compatibility – Perfect fit Glock 17
- Durable Materials: Made of high-quality polymer material. Smooth matte texture and high-standard polymer material protect your skin from irritating weapon chafing.
- Adjustable Straps: Features adjustable straps for a customized fit, enhancing comfort and stability during extended wear.
- Quick Release System: Equipped with a quick-release buckle for fast and efficient access to your firearm in critical situations.
- Versatile Application: Ideal for military, law enforcement, and tactical use, offering versatile carry options and dependable performance in the field.
- Color : Black / Tan



Holster Fibre Colt 1911

- Model Compatibility – 1911 models.
- Durable Materials: Constructed from high-quality, durable materials to withstand tough conditions and rigorous use in any environment.
- Adjustable Straps: Features adjustable straps for a customized fit, enhancing comfort and stability during extended wear.
- Quick Release System: Equipped with a quick-release buckle for fast and efficient access to your firearm in critical situations.
- Versatile Application: Ideal for military, law enforcement, and tactical use, offering versatile carry options and dependable performance in the field.
- Color : Black / Tan



Holster Fibre Berreta M92

- Model Compatibility: Beretta M92 / M9 series
- Durable Materials : High-quality injection-molded polymer; offers durability and resistance to wear
- Adjustable Straps: Features adjustable straps for a customized fit, enhancing comfort and stability during extended wear.
- Quick Release System: Equipped with a quick-release buckle for fast and efficient access to your firearm in critical situations.
- Equipped with a paddle-style back for attaching the holster to a belt or waistband.
- Color: Black / Tan



Gun Socks

- 100% soft polyester with silicone treatment
- Protects guns during storage or travel
- Prevents scrapes, dings, rust, and marring
- Keeps moisture off guns in storage
- Additional protection for metal items in safes
- Fits most guns, with or without scopes
- Also suitable for fishing rods
- Folds/rolls up for easy storage
- Available in multiple colors: black, green, dark grey
- Dimensions: approximately 140*11cm



SUTTER Rifle Bag Premium

Size: 125x35x12cm Black

For rifles, guns and shoulder arms

- Ideal for storing or transportation
- Build-in convoluted foam paddings
- Adjustable shoulder strap and carrying handle

PLINKING & CHRONOGRAPH

Plinking

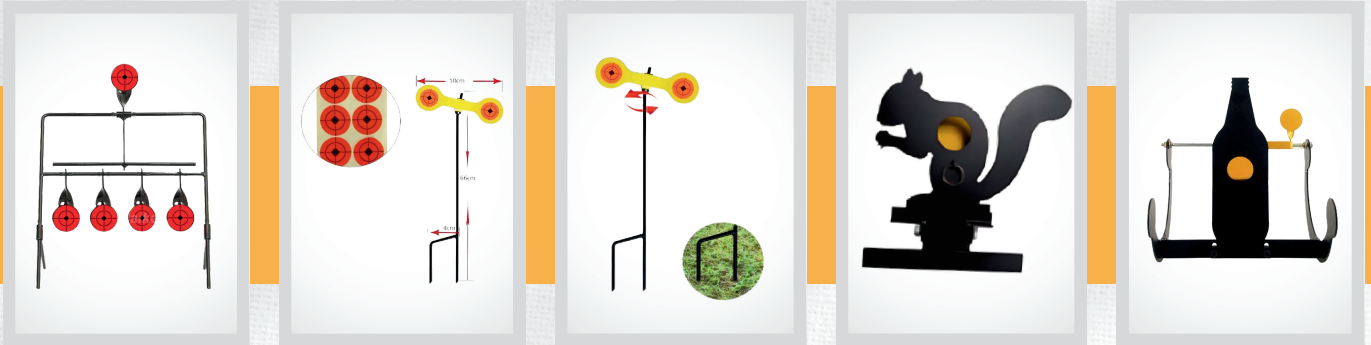

- Perfect for training great for plink coasting or gaming, automatically reset, meets the requirements of continuous shooting practice.
- Lightweight portability Quick and easy assembly, just push into the ground and fire away. Fold flat for easy storage and transport.
- Material: durable and high-quality stainless steel construction stand the target strength for time strict and durable.

Chronograph



- Aluminum alloy, stainless steel material, support bar, speed measurement, energy measurement, speed energy, viewing records and see average.
- It is mainly used to learn and experience the ability of SCM to process data at high speed, and it can measure the flight speed of different projectiles. Such as: table tennis, badminton, bow, arrows, physical acceleration experiment, projectile free fall experiment, nerf toys speed measurement, children's soft toys, etc.

PLINKING & CHRONOGRAPH



Spinner Target

- Two swing targets
- Self resetting/balancing
- Made of durable steel
- Tough, weather-resistant powder-coating
- Suitable for air pistols and air rifles
- Wrench, screw and spacer included
- Diameter: 4.5 cm diamond/Circle target / 5 cm rooster/pigeon target



Target Roll Sticker

- Self Adhesive Target Stickers For Shooting, Archery.
- High Visibility And Bright Florescent Orange Target Easy To See Down Range.
- You Can Stick It On Any Surface. Make Anything Into A Target.
- Great Accessory For Archery, Shooting Or Hunting Practice.
- Great For Both Long And Short Distance Shooting.



Accutac Bipod

This Accutac Bipod style is ideal for long-range, extreme long-range, bench-rest, and for the airsoft platform. The wide, lowered center allows the rifle to sit between the legs which supports accuracy and helps reduce movement from recoil.

- Leg Length: 25 cm

Atlas Bipod

The Atlas Bipod is a premium, precision-engineered rifle bipod designed for tactical, military, and competition use. Built from durable 6061-T6 aluminum with stainless steel components, it features independently adjustable legs with five locking positions, height adjustability, and smooth pan and cant capabilities. With multiple mounting options including Picatinny and quick-detach systems, the Atlas Bipod offers unmatched versatility and stability for accurate long-range shooting.

- Leg Length : 27 cm



Long Bipod

A long bipod is a rifle support accessory designed with extended leg lengths, typically ranging from 6.5" to 13" or more, making it ideal for shooting on uneven terrain, in tall grass, or from seated/kneeling positions. It offers adjustable height, multiple leg positions, and often features pan and cant capabilities for optimal rifle stability and precision. Perfect for long-range shooting, hunting, or tactical use where extra elevation is needed.

- Leg Length: 65 cm



Swivel Bipod

A swivel bipod is a rifle stabilizing accessory that allows for both vertical support and side-to-side tilt (cant), enabling shooters to level their rifle on uneven terrain. Ideal for hunting and long-range shooting, it provides steady aim while allowing minor adjustments without repositioning the legs. Most swivel bipods feature adjustable leg lengths and mount easily to sling studs or Picatinny rails.

- Leg Length : 25 cm

Barrel Bipod

A barrel bipod is a lightweight, clamp-on support device that attaches directly to the barrel of a rifle. It provides basic shooting stability by offering two foldable legs, ideal for casual target shooting or small game hunting. These bipods are easy to install without tools and are often used on air rifles or rimfire firearms. While convenient and budget-friendly, barrel-mounted bipods can affect barrel harmonics and are not recommended for precision shooting.

- Leg Length: 30 cm



Yoke Stick

A yoke stick is a V-shaped shooting support tool used primarily by hunters and precision shooters. It features a cradle or forked top (the "yoke") that securely supports the fore-end of a rifle, helping to stabilize aim and reduce movement. Often adjustable in height, yoke sticks are lightweight, portable, and ideal for use in uneven terrain or when shooting from a standing, kneeling, or seated position. They offer a quick-deploy solution for improved accuracy in the field.

- Leg Length : 86 cm





Manbily MT 324+U-3 Shooting Tripod

This is combination of a tripod and a clamp. The clamp is U-3 . The ball head is a low center of gravity ball head , and the matching Clamp has wider adjustment range and is suitable for more sizes of shotguns and rifles. The Maximum diameter of the carbon fiber tripod is 32mm, which has good overall load-bearing capacity and is more durable.

- Material: Carbon fiber
- Weight: 2.6KG
- Max load: 20KG

Manbily TS 364U- 3 Shooting Tripod

Compatible with rifles, sniper rifles and other firearms, suitable for hunting, shooting range training or shooting.

Made of carbon fibre, with adjustable leg tubes and rubber foot pads, it can adapt to uneven terrain and provide 4-section screw leg-locking system for secure height adjustment.

- Weight: 3 KG
- Max load: 20KG





Forgrip

- Front vertical foregrip for airgun with inbuilt compact collapsible bipod which is very unique and helpful equipment while shooting air gun.

CO₂ CAPSULES & BB BALLS



CO₂ Cartridges 12 gm

The CO₂ Cylinder – 12g is compatible with any air gun, airsoft, paintball, bike tire inflator or other device which requires a 12g CO₂ cartridge. CO₂ power allows you to shoot in rapid succession without the need to manually pump between shots.



CO₂ Cartridges Umarex 12 gm

Umarex German made CO₂ capsules are high-grade specifically for air guns. It provide clean, reliable power, preventing valve clogs and seal damage. It ensures consistent shooting with tested and high-quality CO₂.

Steel Bearing Balls (Copper)



SCHIEBEN 1000 Pieces

Steel Bearing Balls (Silver)



SCHIEBEN 1000 Pieces

- Steel Iron Balls High Performance: Stainless steel, superior anti-corrosion performance, strong hardness and higher wear resistance.
- Precision: The product has high precision and small tolerance, suitable for many occasions and different precision requirements
- Wide Range of Uses: Precision bearings, instruments, meters, pen-making, fishing gear, finishing and other high-end industries
- Size : 4.5mm



Carbon Fiber Tank
0.42/ 0.5 / 0.7 ltr



Carbon Fiber Tank
0.3 ltr



Carbon Fiber Tank
3 /6.8 ltr

- The carbon fiber cylinder is made with an aluminum core covered by a carbon fiber braid.
- The advantage is the lightness of the cylinder.
- Its thread is in M18x1.5 and its working pressure is 300bar.
- It should be noted that a carbon cylinder has a limited life of 15 years and must, like a steel or aluminum cylinder, be retested at regular intervals according to the legislation in force.
- Carbon fiber cylinders are fragile cylinders. If they are knocked or damaged on their outer surface, they become unusable.
- Product Application: Loading gas, Emergency escape, Fire breathing, Underwater breathing, Lifesaving of ships, Clean energy, Snorkeling diving breathing, PCP rifle and Paintball filling, Medical care and Mine emergency etc.



Buddy Bottle

Buddy Bottle 4500 PSI with "Buddy Bottle" 500CC – 4500 PSI Maximum Working Pressure.

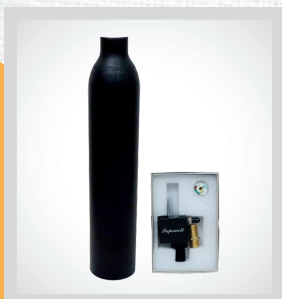

Buddy Bottle with Z-Valve Kit

Buddy Bottle 4500 PSI with Valve Spare Cylinder "Buddy Bottle" 500CC – 4500 PSI Maximum Working Pressure.

Valve

- Air outlet thread: M18/1.5
- Air inlet thread: M18/1.5
- With sealing ring, good sealing
- Standard for any 4500psi High Pressure Air Tank.
- Fit for high pressure cylinder Carbon Fiber Tank



Z Valve

- Innovative Design: Special-shaped Z Valve offers a unique and ergonomic design for excellent hand feel and easy operation.
- High-Quality Material: Constructed from durable aluminum alloy, ensuring long-lasting performance and reliability.
- Anti-Upwind Check Valve: Features an anti-upwind check valve to prevent backflow and maintain consistent pressure.
- Accurate Pressure Display: Equipped with a 5000psi display for precise pressure readings and enhanced safety.
- Versatile Application: Suitable for a variety of uses, making it ideal for both professional and personal applications.



Edgun Eazy Fill Handle

- Zero air waste
- Quicker than traditional valves
- Adaptable to any PCP fill system
- Supplied with a 1/8 BSPP (G 1/8) thread that will adapt to all fill probe sizes and foster
- Foster fitting attachment
- Hard anodizing coating

Combination Valve



- For pressurizing PCP air rifle with a High pressure tank. It comes with a high-quality hose, Pressure gauge, Quick Fill Adapter and air bleed valve.
- Rated Input pressure: 4500psi/300bar Input Thread: M18x1.5
- Material: Stainless steel inner and copper cover Hose
- Two gauge design, One gauge displays the pressure inside the cylinder, and one gauge displays the pressure during inflation.
- It is easy to operate and can be used in various industries such as paintball, PCP, airsoft shooting etc

Scuba Filling Device

- PCP Air Fill Station Filling Charging Adapter
- Quick fill Adapter
- For pressurizing PCP air rifle with a High-pressure tank. Comes with a high-quality hose, Pressure gauge, Quick Fill Adapter and air bleed valve. Needs a fill probe to connect to air rifle / air pistol.



ACCESSORIES



Sling, Imported Double Point

- **HIGH QUALITY:** Constructed with superior quality Nylon material, the sling is strong and durable. Upgraded larger metal hooks fit most sling swivel
- **ADJUSTABLE LENGTH:** The length of sling is adjustable. With adjustment thumb loop and high density cord, the sling can be easily adjusted
- **MULTIFUNCTIONAL:** The sling comes in multipurpose that can be used as rifle-strap, shoulder bag sling, camera belt or even a safety rope



Sling, Imported Single Point

- Grasp strap design for quick length adjustment allow raising your rifle for accurate aim and speedy shoot
- Multi using configurations: Carry the rifle cross on your shoulder as 2 point sling; Wrap around by snapping the D ring as single point sling; two point convert to one point sling easily
- Rotating Zinc-Alloy Clips won't twist the strap, provide better control and large open clip easy attach to rifles' built-in ring or sling attachment adapter
- With quick release buckle, you can install or take down your gun from body easily



Trigger Lock

- Durable Material Construction Positive locking with adjustable ratchet mechanism. Protective rubber pads shield can protect gun finish from scratching.
- The gun locks separates into two halves when opened and locks with an adjustable ratchet mechanism for a snug fit

ACCESSORIES



Gun Safety Steel Sling Rotary Rope

Rope For All Types of pistol, Revolver sling special tactics fighting survival rope.



Camo Tape

Self Adhesive Protective Camouflage Duct Tape, Camo Wrap Waterproof Tape Stretch Bandage Duct Tape for Outdoor Camping, Maple Leaf [50mm x 6m]



Camo Grip Roll

Camo Grip Roll, 1.97in x 14.76ft Adhesive Stretch Cohesive Camo Tape for Outdoor Athletic Sports Bicycle Hockey Skateboard Scooter Bat, 4.92 Yard Waterproof Protective Bandage Cover



Camouflage Tripod Leg Covers

- **Wide Compatibility Tripod Leg Covers:** Designed to fit tripod legs within 32mm in diameter. Note: For max loads 44 lbs (20 kg), pair with tripods that have thicker legs for best stability
- **Easy Setup:** Heavy-duty Velcro straps make setup quick and secure. Simply wrap, stick, and go—fits snugly and stays put during your shoot
- **High-quality Material:** Crafted from premium polyester fabric that resists tearing, water, corrosion, and wear. Built to handle tough environments with ease
- **Camouflage Design for Outdoor Use:** Perfect for wildlife photography or hunting trips, the camo pattern helps your gear blend into natural surroundings
- **What You Get:** 3x 32mm Tube Tripod Leg Covers

SPARES & MAINTENANCE

PX- QD



- Filling adapter quick disconnect
- Suitable for Px 100 with female foster connection

PX Repair Kit

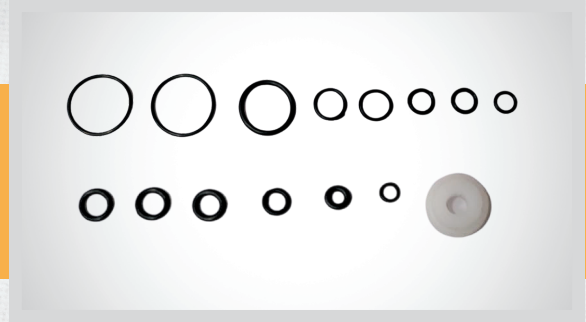

- Repair Kit suitable for Indian Airguns.

Gauge, Compatible with Px



- Pressure gauge suitable for all India Airguns
- It comes with BSPP 1/8" thread.

Gauge For PCP Hand Pump



- Spare gauge for all PCP pumps.

Diana O Ring Kit

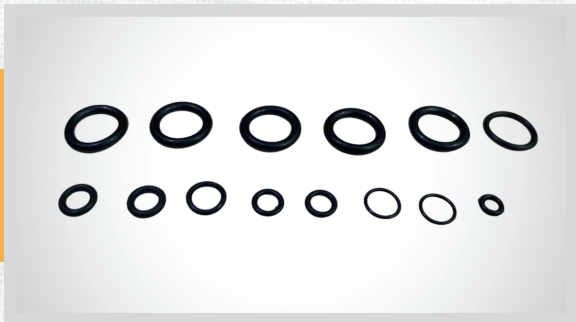

- Repair Kit suitable for Diana Stormrider

Diana Filling Probe



- With the female foster fill on the hose end of the pump or scuba fill kit helps fill multiple airguns with common adapter.
- Made from high grade steel.

SPARES & MAINTENANCE

POWER ENHANCER compatible with Px



- precision-machined shaft for easy insertion and tuning the power of the gun.

Hammer Spring Upgraded PX



- Powerful hammer spring for Precihole PCP.

12 Shot Magazine compatible with PX



- Magnetized rotary magazine.
- 12 shots upgraded magazine.
- suitable for all precihole sports

Male QD with NR



- Male quick disconnect with non return valve.
- Suitable for guns & filling adapters.

Female Fosters



- Female fosters with male & female thread options.



3 Head Mount

- Compatible with most scopes with 30mm tube.
- It is light weight, made of aluminium with black anodized matte finish.
- It comes with insert.

MI Grand Mount

- Fully Picatinny-compatible top rail with 15 slots; accepts Weaver ring and allows use of iron sights. Machined from aircraft-grade aluminium alloy black matte finish.

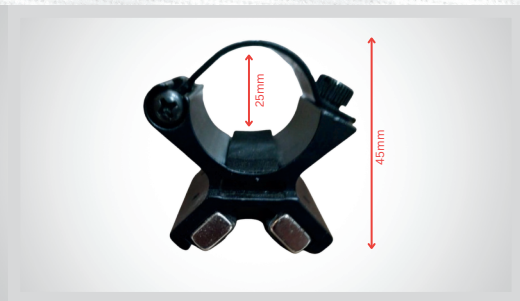

Magnet Mount

Magnetic Mount: with two powerful magnets, powerful magnet in the base can be attached to the device.

Mount DBBL

- Double barrel mount, shotgun Accessories for Laser Sight Flashlight Light Mount Airsoft Shotgun Mount.
- This mount will allow you to fit your accessories such as Lasers, Flashlights etc to you gun barrel.
- Fits any barrel or tube 40 – 45mm diameter. Manufactured in aluminium alloy.
- Designed for shooting and airsoft applications. Attachment and securing are done by 3 Allen key bolts which secure it onto the barrel.





Mount SBBL

- Single barrel Mount, Shotgun Accessories for Laser Sight Flashlight Light Mount Airsoft Shotgun Mount.
- This mount will allow you to fit your accessories such as Lasers, Flashlights etc to you gun barrel.
- Fits any barrel or tube 40 – 45mm diameter. Manufactured in aluminium alloy.
- Designed for shooting and airsoft applications. Attachment and securing are done by 3 Allen key bolts which secure it onto the barrel.

11-11 mm Long Rail



11-11 mm Short Rail



- Two integrated side dovetail rails can install other items for tactical purpose.
- High-durability aluminum alloy in black matt and beautiful complement.
- Shock proof can be used on air gun and real fire caliber.
- Arc shape base can fit your caliber or air gun well.
- Install on 11mm dovetail rail for riser.

Mount 20-30 mm High



Mount 20-25 mm Low



- The Scope Mount Optic Sight Ring 30mm Mounts Base is a perfect solution for firing outdoors with accuracy.
- Its 11mm base make it the ideal choice for slingshot and rifle accessories.
- Enjoy secure mounting & reliable support with this precision-crafted optic sight ring. **28**

11-20 mm Long Rail Converter

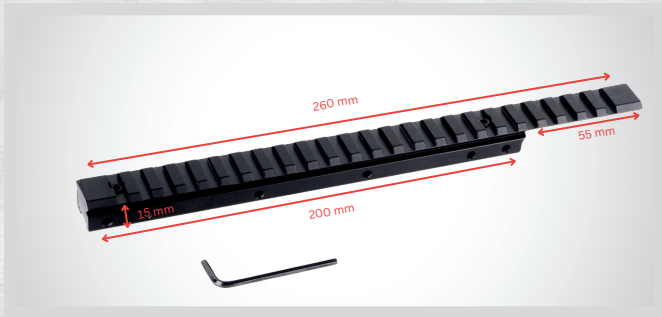

11-20 mm small Rail Converter



- Specially designed to convert 11mm rail base to 20mm rail base.
- Six high-strength locking screws can prevent recoil stop pins to ensure firm locking.
- They are designed to resist bidirectional recoil.

ZR Mount, 11 mm



ZR Mount, 20 mm



- ZR Mount is perfect to mount your amazing rifle scopes . ZR stands for Zero Recoil, so zero recoil! The only assembly that compensates for the recoil for the rifle scope almost 100% and thus prevents damage to the rifle scope.
- With 1 mm forward tilt and stop pin.
- Designed for powerful air rifles.

RWS Mount 25mm Low

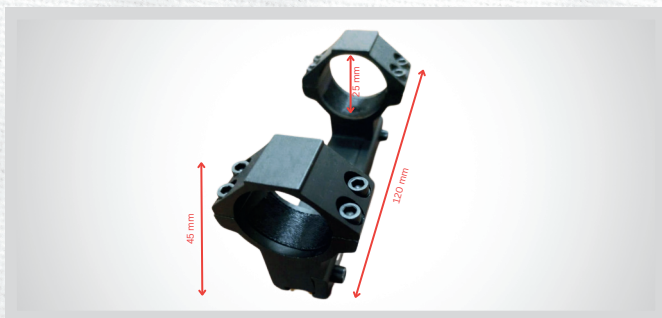

RWS Mount 30mm High

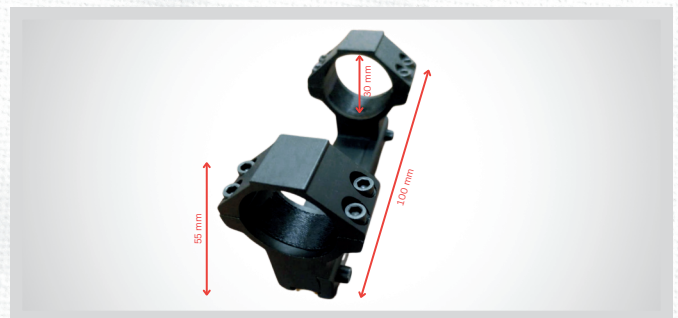

- Made of all alloy metal, black mat, military style, light texture, high strength.
- Design: The mounting base 11mm is see-through design.
- Great for Your Rifles, Pistol, Airsoft.

Mount 11-25mm High (Double Screw)



Mount 11-25mm Low (Double Screw)



- The ring mounts with options of 11 mm & 20 mm of base with various configuration of high and low are available
- Double screw options make it more reliable with stopper pin option.
- Rings size of 20 mm & 30 mm are available in various configuration as per the customer requirement.



Mount 11-30mm High (Double Screw)



Mount 11-30mm Low (Double Screw)

Scope Torch Mount Small

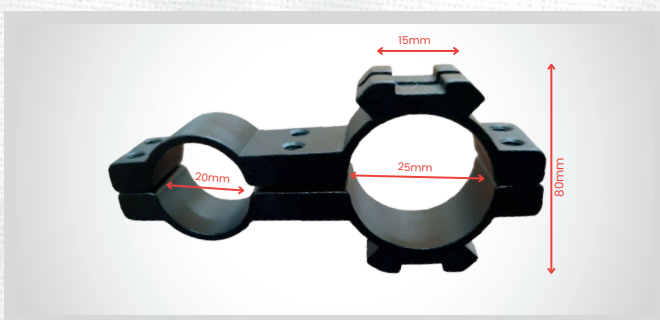

Scope Torch Mount Big

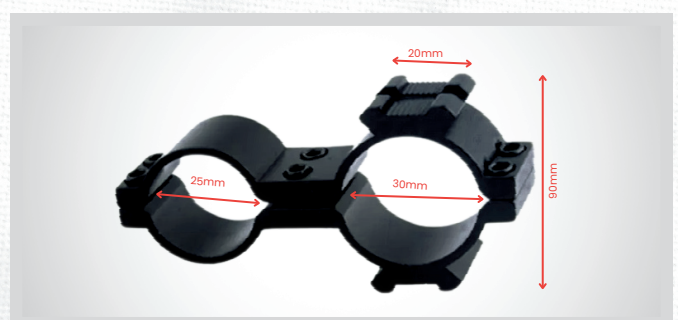

- Perfect to attach your torch to your gun or rifle scope when using the lamps.
- 6 x Allen Screws for a beautiful secure fit
- 2 x side rails for additional mounting options

Mount 11-34mm Low



- The ring mounts with options of 11 mm & 34 mm of base with various configuration of high and low are available
- Double screw options make it more reliable with stopper pin option.
- Rings size of 20 mm & 34 mm are available in various configuration as per the customer requirement.

Mount 11-34mm High



- The ring mounts with options of 11 mm & 34 mm of base with various configuration of high and low are available
- Double screw options make it more reliable with stopper pin option.
- Rings size of 20 mm & 34 mm are available in various configuration as per the customer requirement.

Manbily Shooting Saddle Mount, U-3



The Manbily U-3 Saddle is a steady support with unequalled versatility and portability. This accessory is designed to enhance your shooting experience, ensuring compatibility with most shooting tripods available on the market.

- The minimum opening is smaller than the saddle of the other brand.
- CNC machined thick aluminum body with large knob.
- Premium internal rubber pads.
- Black oxide stainless steel bolt.
- With two 1/4" threads and a 3/8" thread on the bottom, and a standard Arca-swiss base, the saddle can be mounted directly to any hunting tripod platform.
- The large locking knob reduces extra weight and ensures easy adjustment.

Bubble Level



Universal mini size bubble level, convenient to carry.

- Can be used for level measurement of phonograph turntable, headshell and others.
- Clear liquid with green background, easy to use.
- Weight: 9 gm

Laser Bore Sighter New

- With 30 uniquely numbered adapters, it offers unparalleled accuracy for a wide range of calibers.
- Our precision-engineered bore sighter ensures unmatched precision when zeroing in on your target, making it a reliable companion for hunters and professional shooters.



Pistol Torch Double Laser

- The perfect combination of blue and green laser sights and high brightness flashlights in 3-in-1 can meet your shooting aiming and correction needs no matter day or night.



Pistol Torch Single Laser

- Designed with a single-piece mount, this laser sight ensures a stable and consistent zero, enhancing accuracy and reliability during use.



Red Dot Laser Scope

- Tactical Red Laser Sight: This laser scope is built with CLASS IIIa red laser.
- Scope Mount and Rail Mount: This laser sight is equipped with one scope mount and one rail mount.
- Come with one momentary pressure switch, which can brighten up momentarily when you click the button.



Red Dot Holographic sight

- The Electro Series Multi-Reticle Sight is a true breakthrough in optical sights.
- Target acquisition at a split second, pinpoint accuracy and unlimited eye relief, makes this Electro sight ideal for numerous firearms.
- This completely re-invented panoramic design features multiple reticles for optimum versatility.



Tactical Sling Mount

- Sling mount base machined from premium aluminum alloy in black matte anodizing finish, which is extremely lightweight, durable, comfortable and wearable.



Laser Bore Sighter

- This Bore Sighter Bore Sight Kit is ideal for target shooters.
- Laser-aligned and tested to be accurate up to 98%.
- Equipped with a button switch, it includes 2 sets of batteries for both green and red lasers.



Laser Range Finder 700M



Laser Range Finder 1000M



- Designed to withstand outdoor conditions, including rain ensuring reliability & functionality even in harsh weather.
- Its sturdy construction and intuitive operation make it a reliable tool for outdoor enthusiasts

Cleaning Kit

- Complete Cleaning Kit: Includes brushes, rods, patches cleaning solvents for comprehensive firearm maintenance.
- Suitable for various calibers and gun types, making it ideal for all firearm enthusiasts. Keeps all cleaning tools organized and easily accessible for convenient.

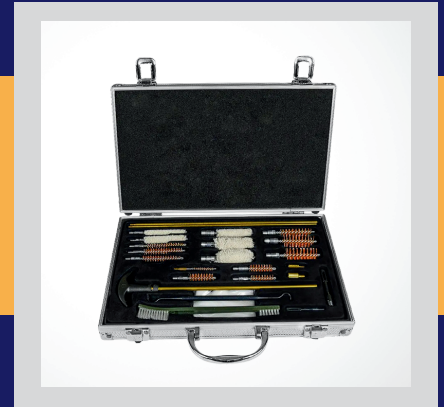

Gun Cold Blue

- Schieben offers you the best ways to touch up scratches and worn spots or even completely reblue most guns. It will give a non-streaky, even blue-black finish to steel (except stainless).
- The proven way for touching up or completely reblueing most guns
- The fast-acting liquid gives a non-streaky, uniform blue-black finish



Gamo Cleaning Kit 0.177 & 0.22

- Gamo.177 &.22 Airgun Cleaning Kit Suitable: for .177 & .22 Rifles and pistols (4.5mm & 5.5mm)
- Light and portable - It can clean up the dirt without scratching the surface of the airgun
- Suitable for cal.4.5/5.5mm gun with cleaning kit with rods, brushes & cleaning Patch - Plastic package, easy to organize



Cleaning Kit 0.177 & 0.22

- Cleaning Kit - Rifle/Pistol Airgun Rifle Brushes Features: - High quality copper material, durable and convenient.
- Light and portable - It can clean up the dirt without scratching the surface of the airgun
- Suitable for cal.4.5/5.5mm gun with cleaning kit with rods, brushes & cleaning Patch - Plastic package, easy to organize





Rifle Rest

For precision shooting and gun maintenance / cleaning

- Horizontal & Vertical adjustments
- Metal construction of two pieces
- Regulating and non-slip base
- Rubber coated rests
- Bench Rest Shooting



SCHIEBEN

Your Schieben Store Journey Begins Here

Thank you for exploring our collection. Each piece is crafted with passion and precision.

 +91 8928146089 / +91 22 4960 3544

 Schiebeninnovations@gmail.com

 www.schiebenstores.com